

Installation Manual and Operating Instructions

TRUE BLUE POWER

TI1200 SERIES

STATIC ELECTRICAL
POWER INVERTER

Manual Number
9017680

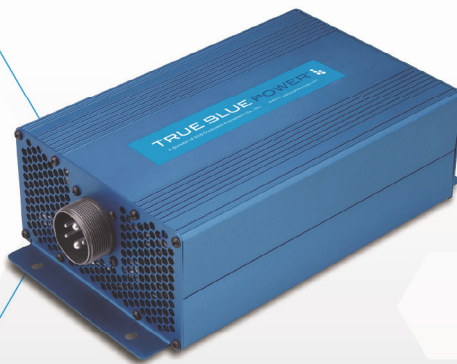

Revision J • May 4, 2020

FOREWORD

This manual provides information intended for use by persons who, in accordance with current regulatory requirements, are qualified to install this equipment. If further information is required, please contact:

True Blue Power
c/o Mid-Continent Instrument Co., Inc.
Attn: Customer Service Dept.
9400 E. 34th St. N.
Wichita, KS 67226 USA
Phone 316-630-0101
Fax 316-630-0723
www.truebluepowerusa.com
www.mcico.com

We welcome your comments concerning this manual. Although every effort has been made to keep it free of errors, some may occur. When reporting a specific problem, please describe it briefly and include the manual part number, the paragraph/figure/table number and the page number. Send your comments to:

True Blue Power
c/o Mid-Continent Instrument Co., Inc.
Attn: Technical Publications
9400 E. 34th St. N.
Wichita, KS 67226 USA
Phone 316-630-0101
Fax 316-630-0723

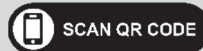

Download the current version of this installation manual using your smartphone or tablet.

© Copyright 2018
Mid-Continent Instrument Co., Inc.

TABLE OF CONTENTS

<u>SECTION 1</u>	<u>GENERAL DESCRIPTION</u>	<u>4</u>
1.1	INTRODUCTION	4
1.2	TECHNICAL SPECIFICATIONS	5
<u>SECTION 2</u>	<u>PRE-INSTALLATION CONSIDERATIONS</u>	<u>6</u>
2.1	COOLING	6
2.2	EQUIPMENT LOCATION	6
2.3	ROUTING OF CABLES	6
2.4	LIMITATIONS	6
2.5	MODIFICATION	7
<u>SECTION 3</u>	<u>INSTALLATION</u>	<u>8</u>
3.1	GENERAL INFORMATION	8
3.2	UNPACKING AND INSPECTING EQUIPMENT	8
3.3	INVERTER CONNECTIONS AND WIRE HARNESS	8
3.4	MOUNTING	12
3.5	INSTALLATION CAUTIONS	12
3.6	INSTALLATION COMPLETION	12
<u>SECTION 4</u>	<u>OPERATION</u>	<u>14</u>
4.1	ELECTRICAL PERFORMANCE	14
4.2	PROTECTIVE FEATURES	15
<u>SECTION 5</u>	<u>CONFORMANCE</u>	<u>18</u>
5.1	CONTINUED AIRWORTHINESS STATEMENT	18
5.2	ENVIRONMENTAL QUALIFICATION STATEMENT	18

REVISION HISTORY

Rev	Date	Detail	Approved
A	04/27/2012	Initial release.	JRC
B	07/23/2012	Page 9; view overlaps. Page 15 (TS) and (TDS) 501 was 500.	JDS
C	01/02/2015	Added TI1202 model.	BMC
D	08/08/2016	Added 6431200-5 model.	VAA
E	12/30/2016	Added the -2, -4, and -5 models to Table 1.1.	KJW
F	02/27/2017	General update to entire manual. Added 6431200-6 model. Add capacitor/noise section.	JRC
G	07/17/2019	Added additional DO-160G section category ratings to Table 5.2. Added 6431200-7 with different connector in Table 1.1 and Table 3.3.1. Updated Figure 4.2	JRC
H	08/13/2019	Updated Section 4.2.1, Table 1.1 and 1.2, and Figure 4.2.	VAA
J	05/04/2020	Updated style and brand to meet Marketing and Engineering guidelines. Updated 5.2 EQF table with current data.	DLR

SECTION 1 GENERAL DESCRIPTION

1.1 INTRODUCTION

The model TI1200 series Static Electrical Power Inverter is a lightweight power converter that translates a 20 to 36 VDC input to a variety of application options:

Configurations			
Model	Part Number	Output	Typical Application
TI1200	6431200-1	115 VAC, 60 Hz, 1200VA	General purpose 115V cabin power
TI1200	6431200-2	115 VAC, 60 Hz, 1200VA	Edge mount, non-TSO
TI1202	6431200-3	230 VAC, 50 Hz, 1200VA	General purpose 230V cabin power
TI1200	6431200-4	115 VAC, 60 Hz, 1200VA	High-peak power microwave ovens/coffee makers
TI1202	6431200-5	230 VAC, 50 Hz, 600VA	For aircraft with power-limited electrical systems
TI1204	6431200-6	115 VAC, 400 Hz, 1200VA	General purpose 400Hz aircraft power
TI1204	6431200-7	115 VAC, 400 Hz, 1200VA	Emergency or General Purpose 400Hz aircraft power. MS3102A24-11P Connector.

Table 1.1

The TI1200 Series is designed to provide up to 1200 watts (VA) of power.*

For all TI1200 Family inverters the AC output is defined as a pure sine wave with typically less than 2.5% of total harmonic distortion for clean, noise-free, harmonic-free power to supply loads of corresponding voltage, power and frequency. For the TI1200, the 115VAC 60 Hertz (Hz) is suitable for nearly any common commercial or consumer load rated for a nominal input of 115VAC. The TI1202 is designed for a 230VAC output with an AC frequency of 50 Hz for international equipment. The TI1204 is designed to meet 115VAC 400Hz for aircraft system uses.

The TI1200 Series Static Inverter is FAA certified to Technical Standard Order (TSO) C73 and tested to rigorous environmental standards and levels according to RTCA/DO-160G. The small size and light weight in conjunction with its installation flexibility (inside or outside the pressure vessel) make it an ideal choice for aircraft power needs while reducing the challenges associated with other similar products.

Highlighted features include short circuit protection, overload capability, low voltage shut-down, temperature monitoring, a self-resettable over-temperature disable, and a remote on/off function. The rugged extrusion that houses the unit is designed to help dissipate heat and provide mechanical strength against vibration or other possibilities of damage. Two independent fans allow for a smaller unit, quiet operation, and keep the internal components cool extending the life of the unit.

The True Blue Power TI1200 series has proven to be modular and adaptable to meet a variety of custom applications and modifications. If you have specific functional needs in a power inverter, inquire with the True Blue Power sales team.

* 6431200-5 version has been current limited to produce 600VA max for specific applications.

1.2 TECHNICAL SPECIFICATIONS

Electrical Attributes					
	6431200-1, 2, 4	6431200-3	6431200-5	6431200-6	6431200-7
Input Voltage: (see Figure 4.2)	Rated 28VDC nominal				
	20-36VDC				18-36VDC
Input Power:	60 amps; 0.2A at no load		30 amps; 0.2A at no load	60 amps; 0.2A at no load	
Output Voltage:	115VAC at 60 Hertz	230VAC at 50 Hertz		115VAC at 400 Hertz	
	Pure sine wave, Single Phase, Voltage $\pm 3\%$, Frequency $\pm 0.1\%$				
Output Power:	1200 VA		600 VA	1200 VA	
Power Factor:	-0.8 to +0.8				
Efficiency:	88% nominal				
Total Harmonic Distortion (THD)	< 2.5%	< 3%		< 3.5%	

Table 1.2

Physical Attributes			
	6431200-1, 3, 4, 5, 6	6431200-2	6431200-7
Weight:	7.25 pounds		
Dimensions: (not including connector mate)	12.00 inches long x 6.32 inches wide x 3.45 inches high		
Mating Connector (and cable clamp):	MS3106A24-12S, MS3106E24- 12S or equivalent (MCI P/N 9017235-1)	MS3106A24-11S or equivalent (MCI P/N 9019110-2)	
Mounting:	Base mount – orientation not critical	Edge mount	Base mount – orientation not critical

Table 1.3

Qualifications (excluding -2)	
FAA Qualification:	TSO-C73
Environmental Qualification:	RTCA DO-160G; see Section 5.2 for details
Altitude:	-15,000 ft. to +55,000 ft.; See Figure 4.3
Temperature:	-55°C to +70°C (-67°F to +158°F); See Figure 4.1

Table 1.4

SECTION 2 PRE-INSTALLATION CONSIDERATIONS

2.1 COOLING

No external cooling is required. The unit is equipped with two internal DC fans. Restriction to airflow can cause overheating of the unit and limit performance or reduce the expected life of the product. Make sure to provide adequate clearance on both ends of the unit with the hexagonal openings to allow for proper circulation. In general, four to six inches of clearance on both ends of the unit should be acceptable. Mounting the unit to a metal surface can also help reduce the effects of temperature within the unit but is not required.

2.2 EQUIPMENT LOCATION

The TI1200 Series Static Inverter is designed for mounting flexibility, allowing for installation inside or outside the pressure vessel with no requirement for temperature control. In addition to altitude and temperature resistance, the unit is also designed to withstand high levels of condensing humidity. Installation locations where the unit could be subject to standing or direct water exposure should be avoided. The unit can be mounted in any orientation. Clearance should be provided for the mating connector and may require as much as five inches past the unit connector to allow for back shell access to the connector.

2.3 ROUTING OF CABLES

The wires and cable bundle associated with the unit are heavy gauge wire and carry significant power. Be aware of routing cables near other electronics or with other wire bundles that may be susceptible to high energy flow.

Avoid sharp bends in cabling and routing near aircraft control cables. Also avoid proximity and contact with aircraft structures, avionics equipment, or other obstructions that could chafe wires during flight and cause undesirable effects.

2.4 LIMITATIONS

The TI1200 Series of static electric power inverters is certified to FAA TSO-C73 with the following limitations identified:

- 1) Alternating current (AC) output is provided at 115 volts and 60 Hertz in lieu of 115 volts and 400 Hertz as identified in the MPS of the TSO. This applies to the TI1200 models. Performance complies fully with all tests and requirements of the MPS of the TSO accordingly.
- 2) Alternating current (AC) output is provided at 230 volts and 50 Hertz in lieu of 115 volts and 400 Hertz as identified in the MPS of the TSO. This applies to the TI1202 models.
- 3) Equivalent environmental qualification was verified per RTCA DO-160G in lieu of those identified within the MPS of the TSO.

The conditions and tests for TSO approval of this article are minimum performance standards. Those installing this article, on or in a specific type or class of aircraft, must determine that the aircraft installation conditions are within the TSO standards, specification of the article, and deviations as listed above. TSO articles must have separate approval for installation in an aircraft. The article may be installed only according to 14 CFR part 43 or the applicable airworthiness requirements.

2.5 MODIFICATION

This product has a nameplate that identifies the manufacturer, part number, description, certification(s) and technical specifications of the unit. It also includes the “MOD” or modification number representing notable changes in the hardware design of the unit.

Modification (MOD) 0 is the initial release of the product and is identified on the nameplate by the lack of marking on the MOD numbers 1 through 9 (i.e. 1-9 are visible). All subsequent modifications are identified on the nameplate by the marking/blacking out of that particular MOD number (i.e. for MOD 1, the number 1 is not visible and 2-9 are visible - see Figure 2.1 for examples). MODs do not have to be sequentially inclusive and may be applied independent of each other.

For additional details regarding specific changes associated with each MOD status refer to the product published Service Bulletins at www.truebluepowerusa.com.

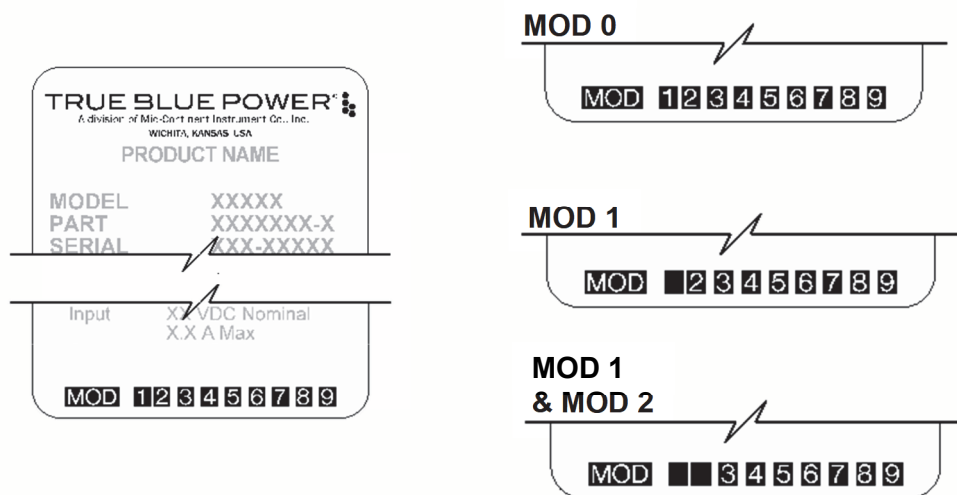

Figure 2.1
Nameplate and MOD Status Example

SECTION 3 INSTALLATION

3.1 GENERAL INFORMATION

This section contains interconnect diagrams, mounting dimensions and other information pertaining to the installation of the TI1200 Series Static Inverter. After installation of cabling and before installation of the equipment, ensure that power is applied only to the pins specified in the interconnect diagram.

3.2 UNPACKING AND INSPECTING EQUIPMENT

When unpacking this equipment, make a visual inspection for evidence of any damage that may have incurred during shipment. The following parts should be included:

- | | |
|-------------------------------------|---|
| A. Static Inverter | MCI P/N 6431200-() |
| B. Mating Connector (& cable clamp) | For most TI1200 models MCI P/N 9017235-1
(MCI P/N 9017235-2 cable clamp)
For 6431200-7 use MCI P/N 9019110-1
(MCI P/N 9017235-2 cable clamp) |
| C. Installation Manual | MCI P/N 9017680 |

Equipment not provided:

- | | |
|-----------------------|---|
| A. Mounting Hardware | four (4) ¼-20 pan head screws
¼" lock washers (optional) |
| B. Cable Harness Wire | See Section 3.3 for specifications |

3.3 INVERTER CONNECTIONS AND WIRE HARNESS

3.3.1 TI1200 Connectors

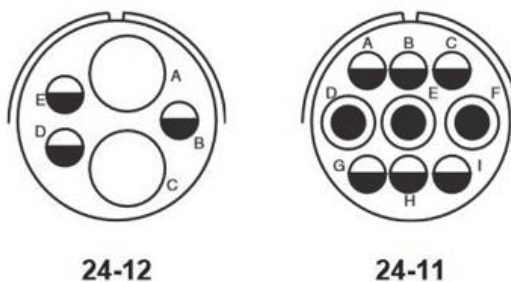

Figure 3.3.1 Connectors for 6431200-1 through -6 (Left) and 6431200-7 (Right)

3.3.2 Pin Assignment Information

Most TI1200 models use a MIL-5105 5-pin 24-12 contact arrangement. The TI1204 model 6431200-7 uses the 24-11 contact arrangement. With all TI1200 models, there are two power input pins, two AC output pins, and one pin used for ENABLE control.

	6431200-1, 3, 4, 5, 6	6431200-7	Recommended Wire Gauge
Mating Connector	MS3106A24-12S or MS3106E24-12S	MS3106A24-11S or MS3106E24-11S	
28VDC Power In	Pin A	Pin D	8 AWG
28VDC Power Return	Pin C	Pin F	8 AWG
AC Volt Output	Pin B	Pin B	14 AWG
AC Volt Return	Pin D	Pin C	14 AWG
ENABLE	Pin E	Pin E	16 to 24 AWG
Unused Pins		Pins A, G, H, I	

Table 3.3.2: Connector Pinouts and Recommended Wire Gauge

3.3.3 Pin Description Information

Inverter Power Input:

28VDC Input (Positive) – Normally +24 to 32 VDC from the aircraft 28 VDC power bus through a circuit breaker.

28VDC Return (Negative) – Internally this pin is isolated from the inverter case/chassis. Typically this lead is connected to aircraft ground. In aircraft with a negative return bus connect this lead to the return bus.

Common practices for the connecting the -28V of power devices in aircraft vary. The TI1200 Series passes DO-160G Section 21 conducted emissions testing using both methods (below) as listed in Section 5.2 of this report.

1. The negative lead connects from the device to the negative power bus.
2. The negative lead connects from the device to the negative power bus, and a second lead connects to the aircraft structure close to the power device.

Inverter AC Output:

The AC output pins of the TI1200 series inverter are isolated from the inverter case/chassis. AC Volt Output – 115VAC, 60Hz, 400Hz or 230VAC, 50Hz. The AC output can be considered as “Line” or “Hot” when referenced to terrestrial/utility power designations. AC Volt Return – The AC return can be considered as “Neutral” when referenced to terrestrial/utility power designations.

On/Off ENABLE Control:

For most TI1200 models (6431200-1 through -6) the inverter output is ENABLED by connecting the ENABLE pin to either DC Negative or to aircraft ground. If the inverter is to be ENABLED at all times then the ENABLE pin can be connected directly to DC Negative. By utilizing a switch between this pin and ground or negative, the switch will allow remote on/off control of the unit.

For the TI1204 6431200-7 model only, the inverter is ENABLED if this connection is open or connected to ground. To turn the inverter OFF remotely, a switch must be used to pull-up this pin to 28 VDC positive.

On all models the ENABLE pin has approximately 11 VDC present from an internal source and is limited to less than 1 mA. A small low-current relay or open-collector transistor can be used to control ENABLE from other systems.

3.3.4 Wire Selection

Use of PTFE, ETFE, TFE, Teflon, or Tefzel stranded insulated wire is recommended for aircraft use. Use the wire gauges for each of the pins in the connector per table 3.3.2:

Note – Because of lower current requirements, the TI1202 600VA 6431200-5 model can be installed using 10 AWG for 28VDC input power and 16 AWG for the AC output.

3.3.5 Circuit Breaker on Input Power:

Connect TI1200 1200VA models to the aircraft 28 VDC bus using a 60-70 Amp circuit breaker. (For the 600VA 6431200-5 use a 30 or 35 Amp circuit breaker.)

3.3.6 Circuit Breakers on AC Output:

Use of a circuit breaker on the AC output is optional. On 115VAC models a 10 Amp circuit breaker is sufficient for the full inverter 1200VA output. For 230VAC /1200VA models use a 5 Amp circuit breaker. For, 230VAC/ 600VA models use a 2.5 Amp circuit breaker. For convenience at each AC outlet, individual circuit breakers of 1 to 5 amps each can be used. If a single pole breaker is used, install the breaker on the AC Output. If a double pole breaker is installed route the AC Output and the AC return through the circuit breaker.

3.3.7 Use with GFI, Noisy electronics, and other Earth/Neutral Situations

The TI1200 series of inverters is fully electrically isolated from the DC input as indicated by TSO-C73, and provides a balanced AC output where AC output and AC return are not associated with the inverter case ground. This is different from terrestrial AC systems where Neutral is connected to ground at an AC distribution transformer at the power mains.

Some consumer items contain internal power supplies that require an Earth-Neutral connection for their noise filters to work properly. Similarly, some GFI protection will not function properly if there is not an Earth/Neutral connection or if there is noise between Earth and Neutral.

If consumer video electronics exhibit noise interference, if touch-screen devices exhibit erratic touch-screen operation, or if added GFI systems exhibit false-tripping, then it is recommended to place a capacitor between the inverter AC return (pin D) and the inverter chassis ground or airframe. This capacitor can be located anywhere between the inverter output and the further-most AC outlet. A film capacitor, metalized polyester or metalized polypropylene with a value between 0.047uF and 0.1uF rated for at least 200VAC (for 115VAC inverter output voltage) or 300VAC (for 230VAC inverter output voltage) can be used.

3.3.8 Harness Verification

With the TI1200 Series Static Inverter disconnected, activate the aircraft power bus that supplies the unit and use a multi-meter to verify that aircraft power and ground with appropriate voltage is on the pins within the mating harness.

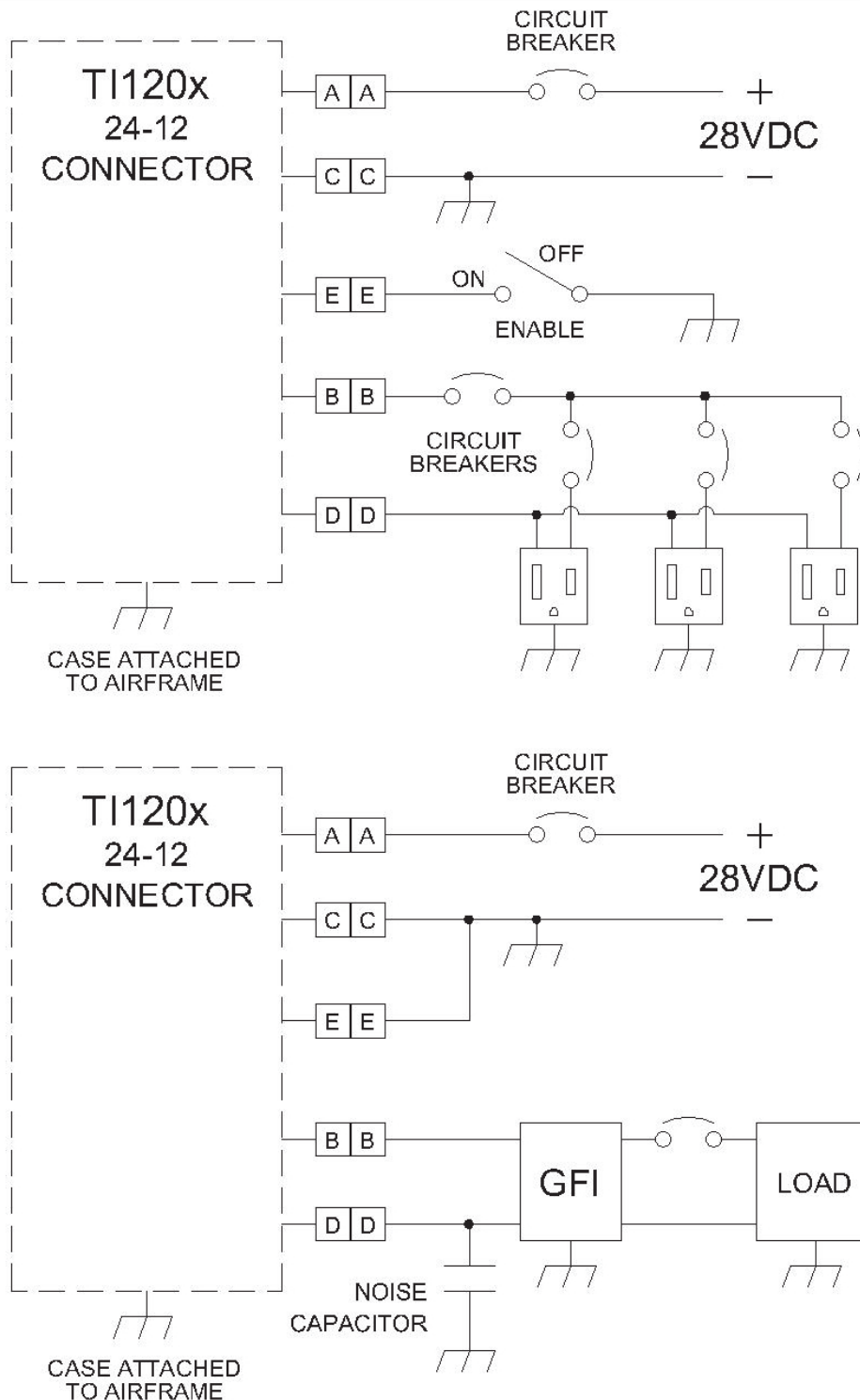

Figure 3.4 Example Wiring Diagrams

(Only Fig 3.3.1 pin numbering for 24-12 style connector shown)

The wiring diagrams of Figure 3.4 provides general examples of typical installations. The configuration of individual aircraft installations may vary. Refer to Section 3 of this manual for circuit breaker rating(s), recommended wire sizes, and other details as these vary with the different model inverter output voltage and power ratings. The different connector of the 6431200-7 is not shown in these diagrams.

3.4 MOUNTING

Refer to Section 2: Pre-Installation Considerations in regards to equipment location.

The T11200 Series Static Inverter is designed for base mounting only. Four ¼-20 mounting holes should be provided in the aircraft in accordance with Figure 3.5. Secure the unit with four ¼-20 pan head Phillips screws, or equivalent. A lock-washer under the head of each screw is recommended.

3.5 INSTALLATION CAUTIONS

The T11200 series is not protected against reverse polarity on the input 28VDC. Verify the voltage polarity on the connector before connecting to the T11200 for the first time.

The T11200 series does not have the ability to phase sync the output to other AC power sources. Do not connect the output of the T11200 to any other inverter or AC source or damage to the T11200 will result.

NOTE – Digital meters measure AC voltage with a very high impedance. As noted in section 3.3.7 the T11200 series has a balanced AC output that is not referenced to the chassis. If a digital meter is used to measure the AC output to chassis, the reading will correspond to approximately ½ the inverter rated output voltage. This reading may vary depending upon the presence of an optional noise capacitor (section 3.3.3), permanently wired accessories, or presence of an external GFI. However, this voltage is not a problem and is a result of using a high-impedance meter to measure AC voltages.

3.6 INSTALLATION COMPLETION

Prior to operating the unit in the aircraft, it is recommended to verify the output and functionality of the unit. In order to prevent accidental damage to other systems, it is best not attach the output to other equipment or power busses prior to verification.

Verify the output of the unit at the terminating end of the cable with a multi-meter to ensure proper voltage and polarity. Once verified, installation can be completed and functionality of the remote on/off feature (if used) should be checked.

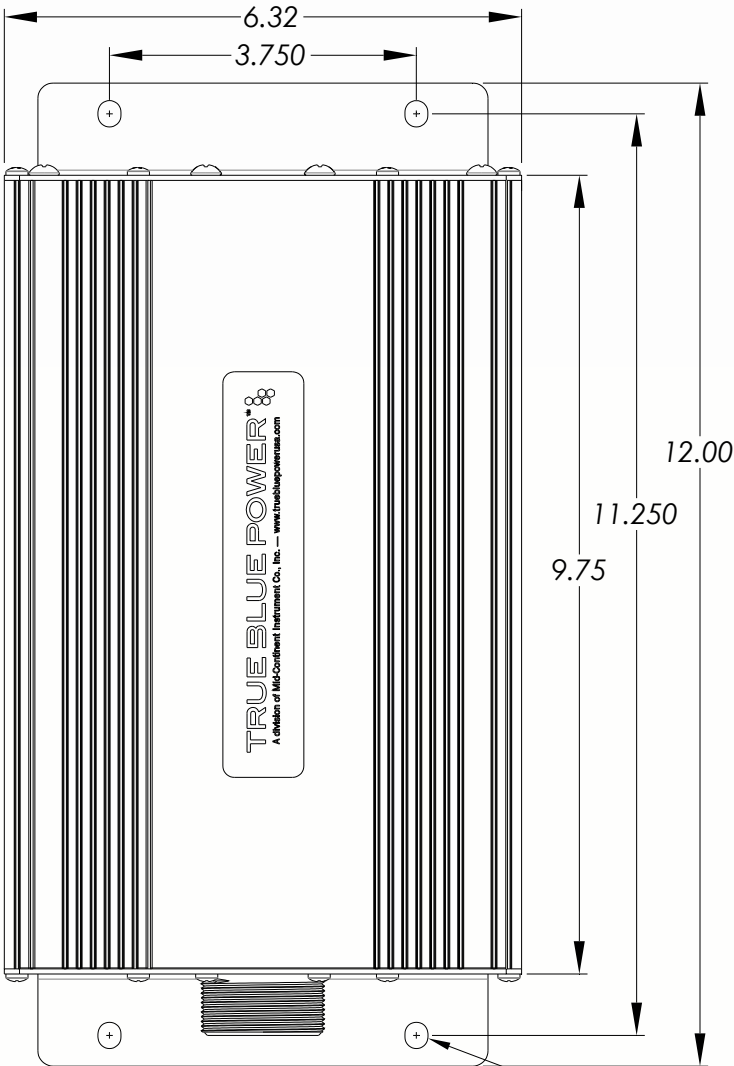

(4x) \varnothing 0.281
1/4-20 Mounting
Holes

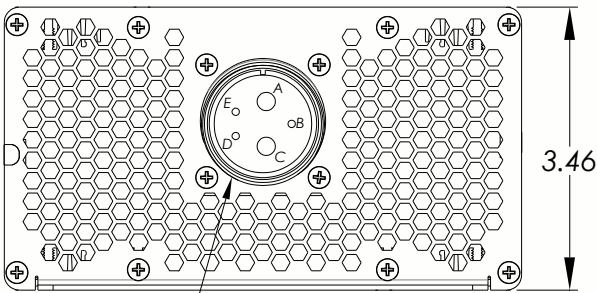

Connector per
MS3102A24-12P

Fan Air Exhaust at connector End

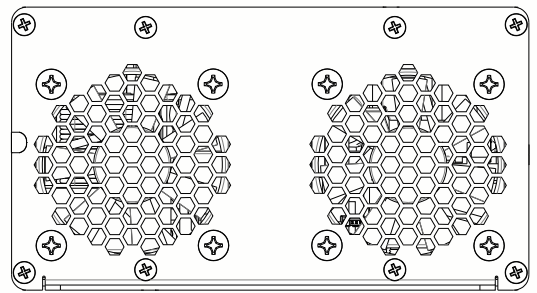

Fan Air Intake at this end of Inverter

Figure 3.5 TI1200 Series Outline Drawing

SECTION 4 OPERATION

4.1 ELECTRICAL PERFORMANCE

The TI1200 Series Static Inverter converts a direct current (DC) voltage input to a regulated, pure sine wave alternating current (VAC) output. Different models provide for outputs of 115 VAC 60 or 400 Hz, and 230 VAC 50 Hz. The unit is capable of providing 1200 watts to power a variety of aircraft accessories including laptops, personal electronics, onboard systems, and many others. For aircraft or helicopters where less electrical system current is available, a 230VAC 600 VA model of the TI1200 is available. (See Table 1.2 for tolerance ranges)

The TI1200 series is designed as a two-stage, solid-state switch-mode power supply. The power transformation utilizes a first-stage full-bridge methodology followed by an H-bridge AC forming second stage. The primary stage utilizes ‘current-mode’ control providing instantaneous load protection as an advantage over legacy designs that incorporate ‘voltage-mode’ controllers. The alternating current is frequency controlled using a crystal oscillator reference.

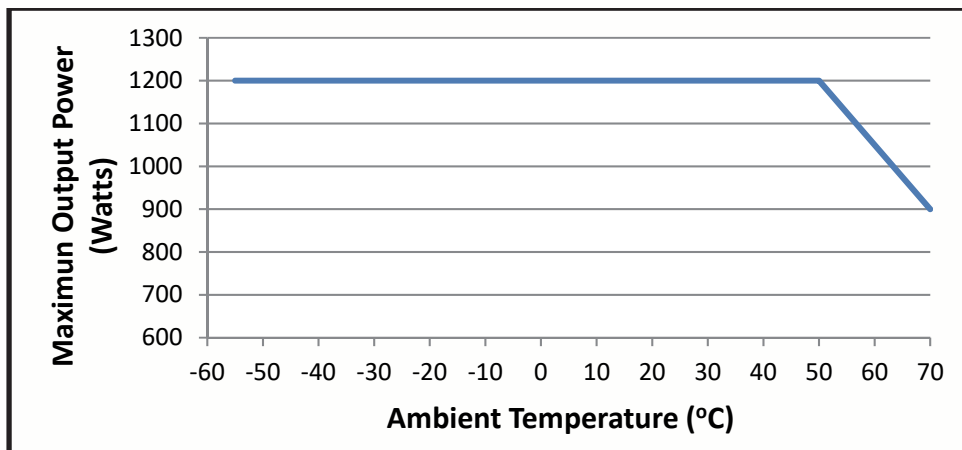
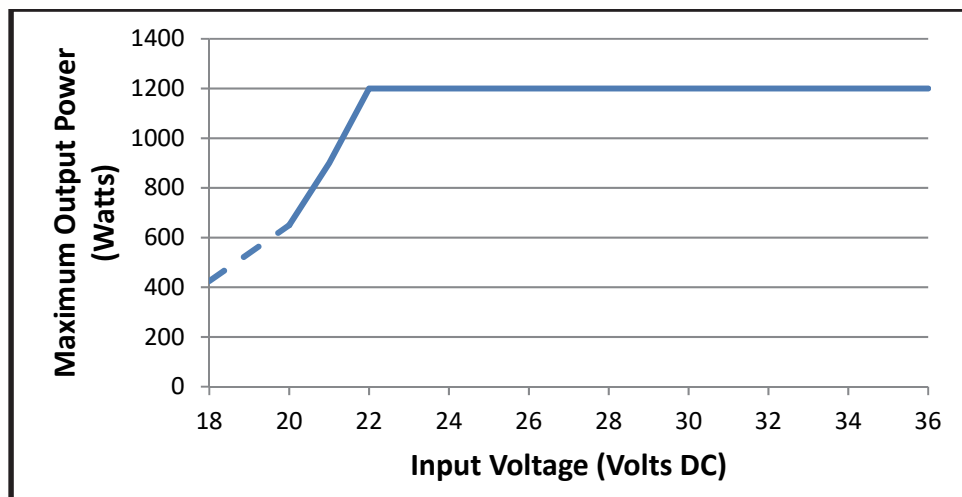

Figure 4.1

Output Power Performance vs Temperature



Dashed line represents operation between 18-20V for -7 version only

Figure 4.2

Output Power Performance vs Input Voltage

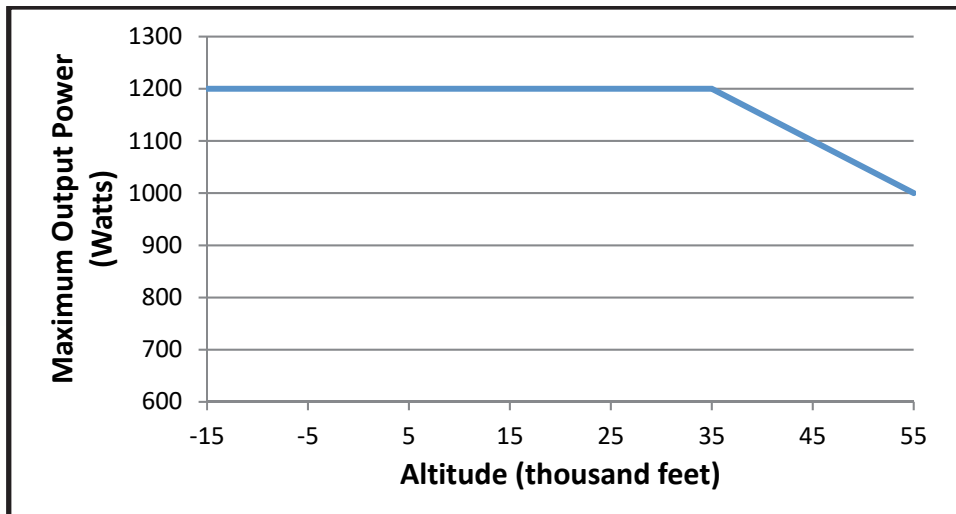

Figure 4.3
Output Power Performance vs Altitude

4.2 PROTECTIVE FEATURES

4.2.1 Remote On/Off

The TI1200 Series Static Inverter incorporates a remote on/off feature that allows the user to enable or disable the output of the unit. By providing a ground on the appropriate pin (See Table 3.3.2) the user, via a remote mounted switch or similar method, can enable the output of the unit. The unit can be similarly disabled by removing the ground signal (open circuit) to the same pin.

For the TI1204 6431200-7 model only, the inverter is ENABLED if this connection is open or connected to ground. To turn the inverter OFF remotely, a switch must be used to pull-up this pin to 28 VDC positive.

4.2.2 Over-Voltage

When the input voltage exceeds the operating range of the unit (See Table 1.2; Input Voltages) the unit senses an over-voltage condition and disables the output. The unit will dynamically monitor the input voltage such that if the input returns to within the normal operating range, the output will be enabled and allow the unit to operate normally.

4.2.3 Under-Voltage

When the input voltage drops below the operating range of the unit (See Table 1.2; Input Voltages) the unit senses an under-voltage condition and disables the output. The unit will monitor the input voltage such that if the input returns to within the normal operating range, the output will be enabled and allow the unit to operate normally.

4.2.4 Over-Temperature

The T11200 Series incorporates an internal temperature sensing device that provides monitoring to the control circuits. When the unit senses an internal condition that exceeds maximum temperature, the inverter output is disabled and the internal cooling fans will continue to operate. The unit output will again be enabled when the temperature returns to within acceptable limits. This over-temperature reset occurs automatically without any external intervention required.

4.2.5 Short Circuit and Over-Current for the 6431200-1, -2, -3, -5, and -6

The T11200 Series will tolerate short circuit or over-current events without permanent damage or effect to long-term reliability. The unit can provide, over its rated power output, up to 110% of rating or 1320 VA continuously (660VA for the 6431200-5). The power output is limited by temperature, input voltage and altitude as shown in Figures 4.1, 4.2, and 4.3. The T11200 senses output current pulse-by-pulse to determine a short circuit or over-current situation.

If the load exceeds approximately 120% to 130% of rating or 1450VA to 1550 VA (approximately 720 VA for the 6431200-5), the output will limit by clipping the peaks of AC sine wave, limiting the power output.

At loads higher than approximately 1500VA, the inverter will not only clip the peaks of the AC sine wave output, but will begin to cycle the AC output ON and OFF at a 5 to 7 second rate further limiting the output power. Loads connected to the inverter output which use a power-ON momentary pushbutton feature will automatically turn-off when inverter output turns-off which should automatically remove some of the load on the AC circuit. When the inverter output cycles back to ON a few seconds later, the reduced load may allow the inverter to automatically return to continuous normal output.

At a full short circuit, a T11200 series inverter will only draw around 10 amps from the 28V input, and will cycle ON and OFF at a 5 to 7 second rate continuously.

Once the overload or short circuit condition is removed, the AC output will return to normal operation within 7 seconds.

4.2.6 Over-Current and Installation for the 6431200-4

The typical T11200 series provides for an instantaneous peak-power output of greater than 1800 VA. However devices such as microwave ovens using an internal high-voltage transformer with rectified output to a magnetron, or electronic coffee makers that control heating by AC phase-modulating the heating element may be rated for an average of only 1200VA, but may exhibit an instantaneous peak power of 2200VA. For these applications, the 6431200-4 inverter is specially intended to meet the requirements of high peak-power AC loads with high crest power-factor or AC phase-modulated power requirements.

At loads exceeding the overcurrent setting of the 6431200-4, the inverter will clip the peaks of the AC sine wave output. At higher levels than this the AC output will cycle ON and OFF at a 5 to 7 second rate limiting output power. At a full short circuit, the inverter will only draw around 10 amps from the 28V input, and will cycle ON and OFF at a 5 to 7 second rate continuously.

Once the overload or short circuit condition is removed, the AC output will return to normal operation within 7 seconds.

Because the overcurrent operation of the 6431200-4 is set much higher, this model of inverter should be direct wired to the load, or have a dedicated outlet to the item being powered. The output of the inverter should not be available for general cabin use or inadvertent overloading of the inverter could occur damaging the inverter.

4.2.7 Over-Current and the 6431200-7

The T11204 model 6431200-7 does not cycle the AC output ON and OFF at high overload. During high overload and short-circuit this model inverter will power for 8 to 15 seconds before latching OFF. Either the input power or the ENABLE must be cycled to restore inverter output. This inverter operates same as the legacy unit this model replaces.

4.2.8 Temperature Regulated Cooling

The unit is equipped with two internal brushless DC fans for cooling to extend the power range and long-term life. The fans are activated at a specified point determined by the continuous monitoring of the internal temperature. The fans operate very quietly to reduce the audible noise in any environment. The two fans provide independent redundancy for protection of the unit in the event that one becomes inoperative.

SECTION 5 CONFORMANCE

5.1 CONTINUED AIRWORTHINESS STATEMENT

No periodic scheduled maintenance or calibration is necessary for continued airworthiness of the T11200 Series Static Inverter. If the unit fails to perform to specifications, the unit must be removed and serviced by Mid-Continent Instruments and Avionics or their authorized designee.

5.2 ENVIRONMENTAL QUALIFICATION STATEMENT

MODEL NUMBER: T11200 **PART NUMBER:** 6431200-()
DESCRIPTIONS: Static Electrical Power Inverter **CERTIFICATION:** FAA TSO-C73
MANUFACTURER: True Blue Power, a division of Mid-Continent Instrument Co., Inc.
ADDRESS: 9400 E. 34th St. North, Wichita, KS 67226, USA.
SPECIFICATION: Test Specification (TS) 501 Test Data Sheet (TDS) 501
STANDARD: RTCA DO-160, Rev G, dated 12/08/10

CONDITIONS	SECTION	DESCRIPTION OF TEST
Temperature and Altitude	4	Category F3(Y)
Temperature Variation	5	Category S2
Humidity	6	Category B
Operational Shock and Crash Safety	7	Category B
Vibration	8	Fixed Wing: Category R; Curves C, C1 Rotorcraft: Category U; Curve G
Explosion	9	Category H
Waterproofness	10	Category W
Fluids	11	Category X
Sand and Dust	12	Category X
Fungus	13	Category X
Salt Fog	14	Category X
Magnetic Effect	15	Category Z
Power Input	16	Category A (RI)
Voltage Spike	17	Category A
Audio Frequency Conducted Susceptibility	18	Category R
Induced Signal Susceptibility	19	Category AC
Radio Frequency Susceptibility	20	Category RR
Emission of Radio Freq Energy	21	Category B
Lightning Induced Transient Susceptibility	22	Category A3G3
Lightning Direct Effects	23	Category X
Icing	24	Category X
ESD	25	Category A
Fire, Flammability	26	Category C

REMARKS:
 Section 4: Category F3 with excursions as declared by the manufacturer:

- 4.5.3 Ground Survival High Temp: +85°C
- 4.5.3: Short-Time Operating High Temp: +70°C, 75%
- 4.5.4 Operating High Temp: +70°C, 75%
- 4.5.5 Loss of Cooling: 300 minutes; +40°C
- 4.6.2 Decompression: +8,000 feet
- 4.6.3 Overpressure: -15,000 feet